

UTILIZZO

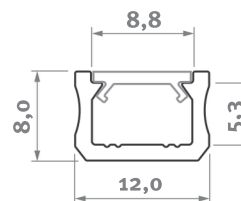

Profilo da superficie - per illuminazione discreta in cucine, negozi - illuminazione di piani di lavoro, corrimano.

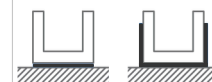



Metodi di assemblaggio



Profili per LED

	Bianco (verniciato RAL9016)	Nero (anodizzato)	Argento (anodizzato)
Colori del profilo			
1,0 m	10-0011-10	10-0012-10	10-0013-10
2,0 m	10-0011-20	10-0012-20	10-0013-20
3,0 m	10-0011-30	10-0012-30	10-0013-30
Larghezza della striscia LED (mm)	fino a 8		

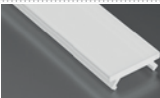
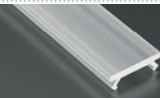
Covers "Velo" (montato dall'alto, snap-on)

	Milky (PMMA)	Frosted milky (PMMA)	Nero (PMMA)
Colori della cover			
1,0 m	10-0011-10	10-0012-10	10-0013-10
2,0 m	10-0011-20	10-0012-20	10-0013-20
3,0 m	10-0011-30	10-0012-30	10-0013-30
	☼ PMMA 39%	☼ PMMA 83%	

Tappi finali (plastica)

CON FORO		
Bianco	Nero	Argento
XERO		
		
ALU 12-0012-10	ALU 12-0012-10	ALU 12-0012-10

SENZA FORO		
Bianco	Nero	Argento
XERO		
		
ALU 12-0012-10	ALU 12-0012-11	ABS 12-0013-01

Accessori

Attacchi per montaggio	
Clip di montaggio "Xero" MINI	Clip di montaggio in metallo "Xero"
	
13-0023-00	13-0013-00

Potenza massima dissipata delle sorgenti luminose a LED

per la temperatura del profilo 55° C	per la temperatura del profilo 65° C
14 W	18 W

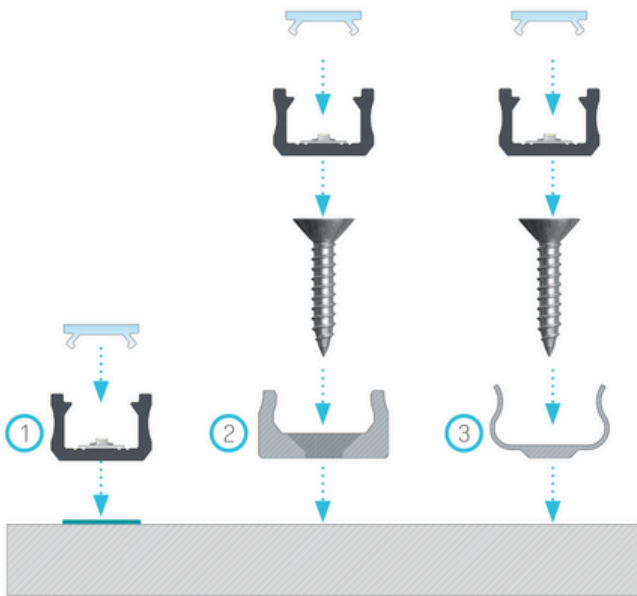

Istruzioni di montaggio del profilo "Xero" con diffusore "Velo" mediante (1) nastro biadesivo, (2) basetta di fissaggio "Xero" MINI, (3) basetta di fissaggio in metallo "Xero".

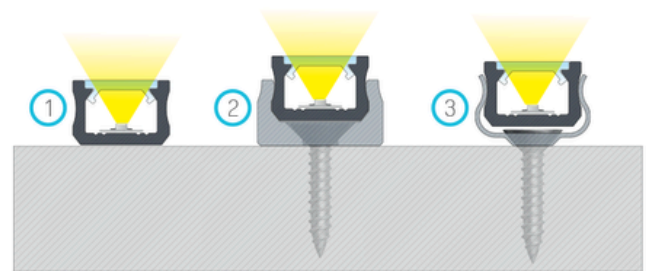

Istruzioni di montaggio del profilo "Xero" con diffusore "Velo" mediante (1) nastro biadesivo, (2) basetta di fissaggio "Xero" MINI, (3) basetta di fissaggio in metallo "Xero".

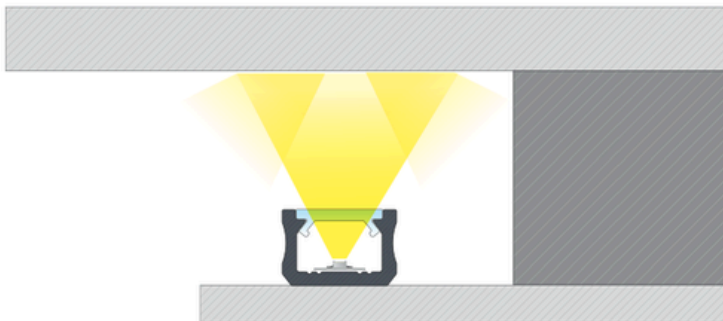

Effetto decorativo del montaggio del profilo "Xero" dietro al bordo di uno specchio.

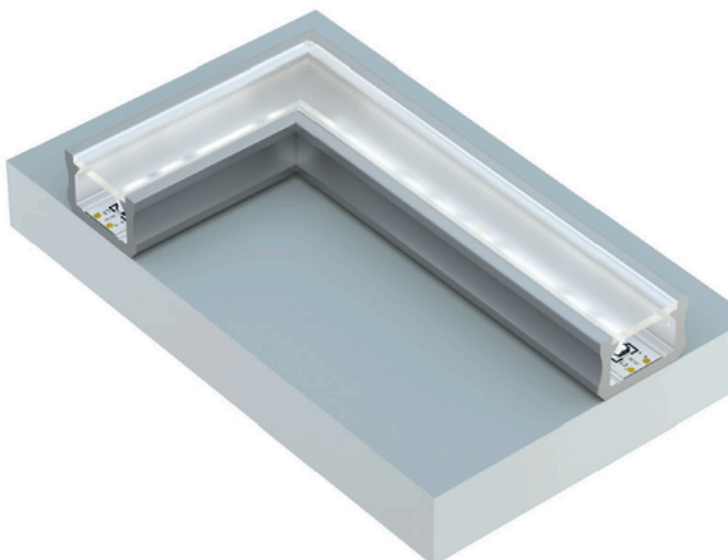

Collegamento dei profili "Xero" con diffusore "Velo" con angolo di 90 gradi.

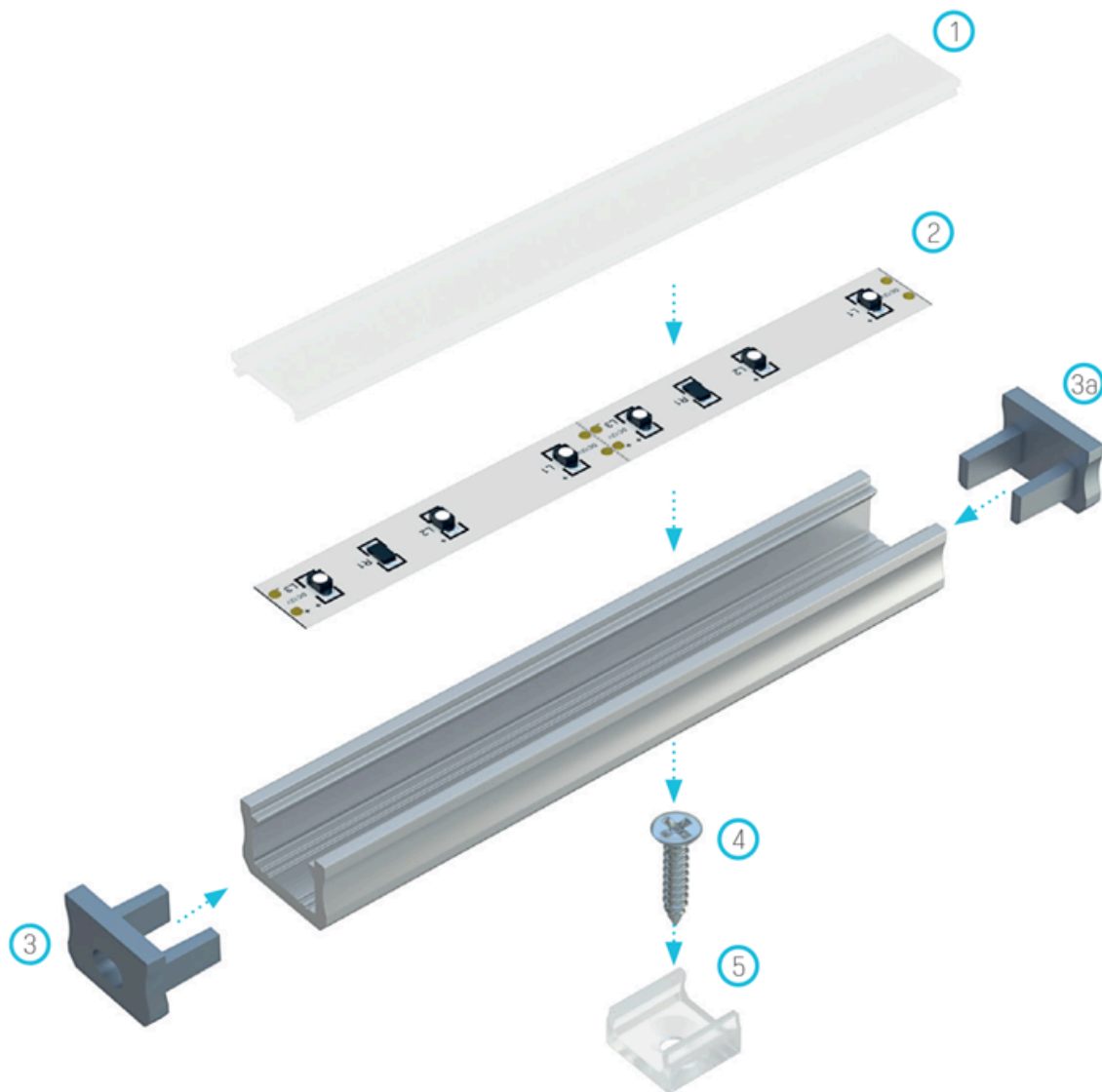

Schema di montaggio degli elementi del sistema di illuminazione con l'uso del profilo "Xero" e (1) del diffusore "Velo", (2) della striscia LED, (3) del tappo con foro, (3a) del tappo senza foro, (4) della vite di montaggio, (5) della basetta di fissaggio "Xero" MINI.

Metodi di installazione di una cover (Semplice, Ampia, Velo)

1. Installazione facendo click

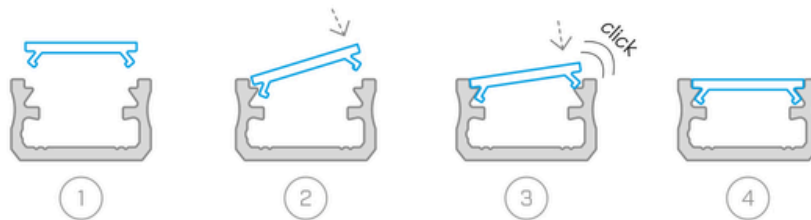

2. Installazione mediante scorrimento nel profilo

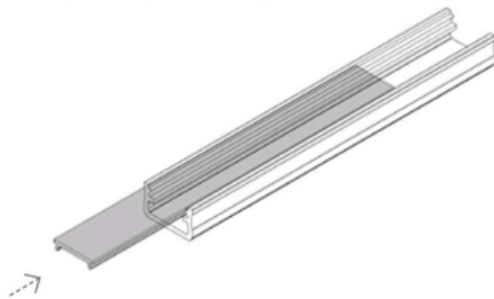

3. Non dovresti avere difficoltà ad inserire la cover, prova a fare clic sulla prima parte e fai scorrere la parte rimanente

