

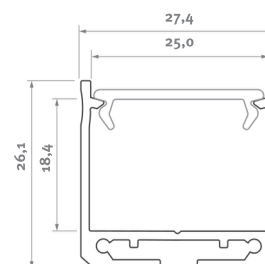

UTILIZZO



Profilo per superfici, destinato a sistemi di illuminazione con l'uso di due nastri.



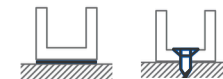

**Metodi di
assemblaggio**

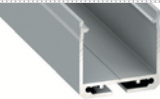

Profili per LED

	Bianco (verniciato RAL9016)	Nero (verniciato RAL9005 opaco)	Argento (anodizzato)
Colori del profilo			
1,0 m	10-0011-10	10-0012-10	10-0013-10
2,0 m	10-0011-20	10-0012-20	10-0013-20
3,0 m	10-0011-30	10-0012-30	10-0013-30
Larghezza della striscia LED (mm)	fino a 2 x 12		

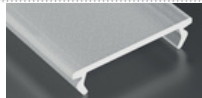
Covers "Duo" (montato dall'alto, snap-on)

	Milky (PMMA)	Frosted milky (PMMA)	Nero (PMMA)
Colori della cover			
1,0 m	10-0011-10	10-0012-10	10-0013-10
2,0 m	10-0011-20	10-0012-20	10-0013-20
3,0 m	10-0011-30	10-0012-30	10-0013-30
	☼ PMMA 50%	☼ PMMA 85%	☼ PMMA 22,67%

Tappi finali (plastica)

CON FORO DI SPINTA		
Bianco	Nero	Argento
ZELO		
		
ALU 12-0012-10	ALU 12-0012-10	ALU 12-0012-10

Potenza massima dissipata delle sorgenti luminose a LED

per la temperatura del profilo 55° C	per la temperatura del profilo 65° C
29,4 W	39,2 W

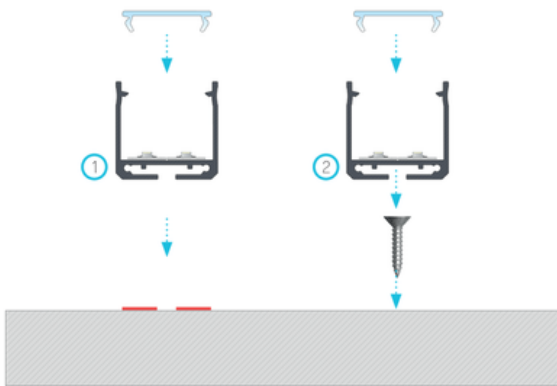

Istruzioni di montaggio del profilo "Zelo" con diffusore "Duo" mediante l'utilizzo (1) del nastro biadesivo e (2) della vite di montaggio.

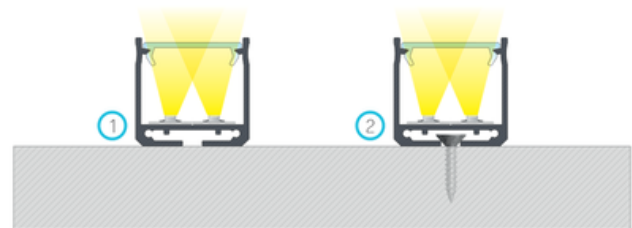

Effetto finale del montaggio del profilo "Zelo" con diffusore "Duo" mediante l'utilizzo (1) del nastro biadesivo e (2) della vite di montaggio.

Schema di montaggio

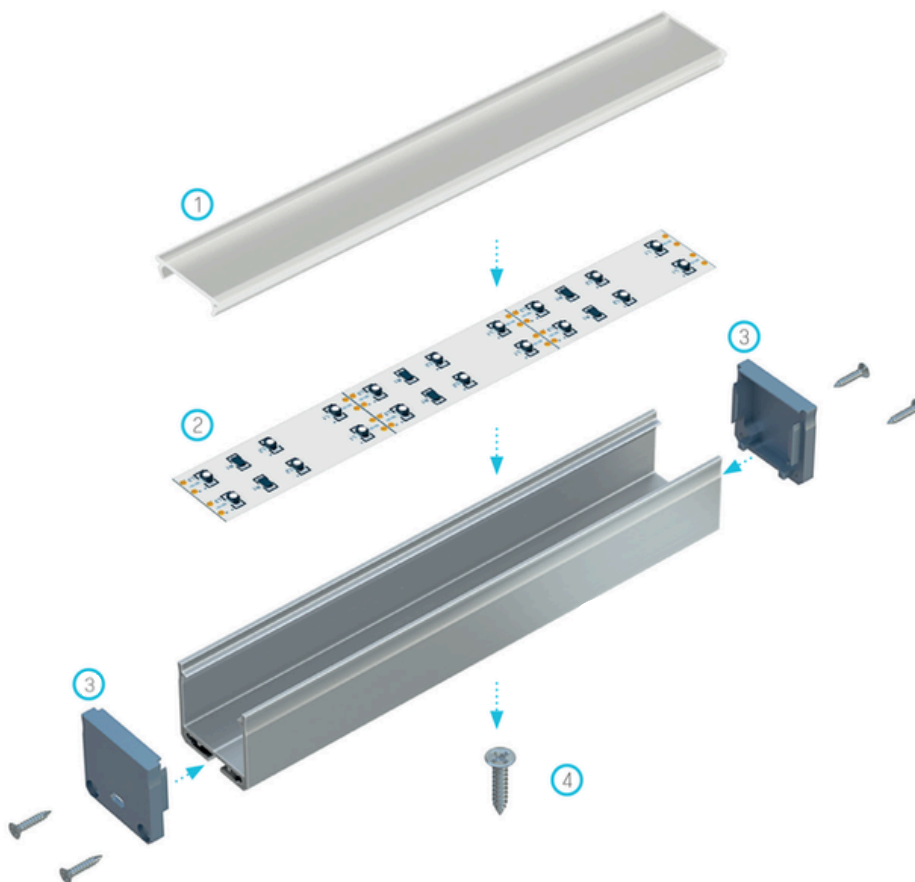

Schema di montaggio degli elementi del sistema di illuminazione con l'uso del profilo "Zelo" e (1) del diffusore "Duo", (2) delle strisce LED, (3) del tappo con foro di spinta e (4) della vite di montaggio.

Metodi di installazione di una cover (Duo)

1. Installazione facendo click

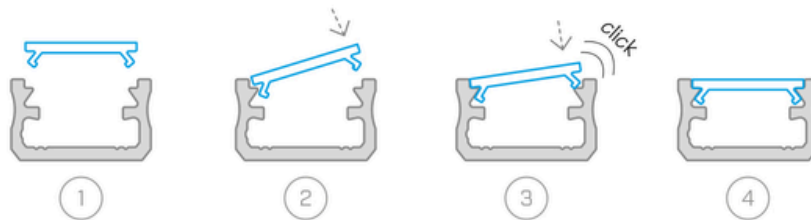

2. Installazione mediante scorrimento nel profilo

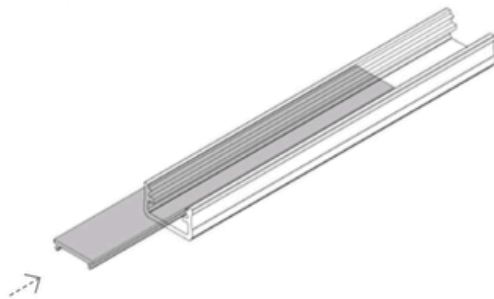

3. Non dovresti avere difficoltà ad inserire la cover, prova a fare clic sulla prima parte e fai scorrere la parte rimanente

